



MY SAFE T PLUS® UNIT

MODEL NO.

SERIAL NO.

INSTALLATION INSTRUCTIONS FOR MOUNTING HARDWARE KIT F-105K2.5

This kit supports installation of SAFE T PLUS®:



MODEL # 41-140 (RED)



MODEL # 41-180 (WHITE)



MODEL #41-230 (BLUE)

STOP KEEP INSTRUCTIONS IN VEHICLE AT ALL TIMES **STOP**

Copyright 2017. All rights reserved. No portion of this manual or any artwork contained herein may be reproduced in any shape or form without expressed written consent.

TABLE OF CONTENTS

IMPORTANT SAFETY INFORMATION.	1
SAFE T PLUS® WARRANTY INFORMATION.	3
KIT CONTENTS & REQUIRED FASTENERS.	5
TOOLS REQUIRED.	6
SAFETY & OTHER RECOMMENDED ITEMS.	7
SAFE T PLUS® INSTALLATION.	10
ROAD TEST & CENTERING.	16
VEHICLE ALIGNMENT SHOP INSTRUCTIONS.	18

Our Commitment to You

We, here at SAFE T PLUS®, are driven by the relentless pursuit to “**Help Drivers Arrive Safely to their Destinations**”.

It is through our uncompromising customer service and focus on producing high quality products that ensures we meet the expectation and satisfaction of the people using our products. Our appreciation of our customers is reflected through the quality of our products and our professional level of customer service. Our commitment to customer service doesn't end when you receive your product. Rather, it is our core principle in building relationships throughout the ownership of your SAFE T PLUS® products.

Thank you from the SAFE T PLUS® Team!

IMPORTANT SAFETY INFORMATION



Before installing your SAFE T PLUS® unit:

- ✓ **Be sure that vehicle is able to maintain a straight-ahead trajectory when driven on a straight and level stretch of road, without drifting left or right. If vehicle tends to drift, you might need to service vehicle alignment in accordance with vehicle manufacturer's specifications.**
- ✓ **Check the condition of vehicle tires. Be sure tires are properly inflated and exhibit normal wear. Correct deficiencies if noted.**



Installing the SAFE T PLUS® unit requires gaining access to the front underside of your vehicle. Be careful when working underneath your vehicle.



Use all tools, safety items, and recommended items in accordance with product manufacturer's instructions.

IMPORTANT SAFETY INFORMATION

! **SAFE T PLUS®** only permits the use and installation of genuine and original Factory Provided/Supplied parts and accessories. **SAFE T PLUS® DOES NOT ALLOW** any replacement, substitute, homemade, or alternative parts or accessories to be used with any products for your safety and to ensure the proper functionality of your **SAFE T PLUS® Steering Control**. **SAFE T PLUS® DOES NOT ALLOW** any of its factory provided parts to be altered, modified, and changed under any circumstance. Failure to use genuine **SAFE T PLUS®** parts could result in product failure, breakage, potential accident, which will immediately void your warranty and any liability of **SAFE T PLUS®**. Your safety is our first priority.

If you need any replacement parts, they may be ordered through **SAFE T PLUS®** distributors, dealers, and the factory depending on your point of purchase. If you need help locating replacement parts, please contact us direct, we would be happy to help.



Steering Control

If vehicle fitted with SAFE T PLUS® unit is involved in an accident, please contact us immediately as your SAFE T PLUS® Steering Control unit and assembly could be damaged.

United Safety Apparatus, Inc

ADDRESS:

1230 Six Flags Road
Building C
Austell, GA 30168

PHONE:

In Georgia, 770-322-8727
OR
800-USA-SAFE (800-872-7233)

FAX:

770-322-9737

www.safe-t-plus.com

For Customer or Technical Service – email at
support@safe-t-plus.com.

VEHICLE ALIGNMENT SHOP INSTRUCTIONS

For future front-end alignments:

1. Gain access to SAFE T PLUS® unit. Using a socket wrench with a 9/16-inch socket, loosen Flanged Lock Nuts on Tie-Rod Bracket U-Bolts so that Tie-Rod Bracket is no longer secured to the Tie-Rod. Be sure Tie-Rod can slide freely between the U-Bolts and Tie-Rod Bracket without binding (Figure 1).
2. After completion of vehicle alignment, ensure vehicle front wheels remain in the straight ahead position. Using a torque wrench with a 9/16-inch socket, torque Flanged Lock Nuts on Tie-Rod Bracket U-Bolts to 25-35 foot pounds (Figure 1).
3. Perform road test in accordance with ROAD TEST AND CENTERING section in this manual.

SAFE T PLUS® WARRANTY INFORMATION

Our team is committed to producing the highest quality Steering Control devices to all our customers. So, in the event that anything is wrong or incorrect with your SAFE T PLUS® Steering Control product(s), we will work hard to make it right for you, and fast.

Any SAFE T PLUS® products damaged in shipping (when ordered directly from SAFE T PLUS® Factory) or defective products must be returned directly to SAFE T PLUS® in the original box or comparable cardboard packing securely protecting the product, freight prepaid. A Return Material Authorization Number (RMA#) must be attained first, and included with the product.

Submit a warranty request claim by completing the below Warranty Request Form or by contacting SAFE T PLUS® at (770) 322-8727 or support@safe-t-plus.com.

Limited Lifetime Warranty

SAFE T PLUS® for Recreational Vehicles (Class, A, B, C and Towable Vehicles) – Lifetime Warranty

SAFE T PLUS® Steering Control products installed on any Recreation Vehicle carries a Limited Lifetime Warranty against defects in material and workmanship. This Warranty only applies to the original purchaser. If any SAFE T PLUS® products are found to be used commercially, or is structurally altered (including mounting brackets, bolt kits, washers, spacers, nuts, etc.), or when non-factory or non-genuine SAFE T PLUS® parts are used, or is damaged as a result of improper installation or abnormal use, warranty and liability will be voided.

Obligation under this warranty shall subject only to the original purchaser from the manufactured date of the product. The manufacturer will replace any SAFE T PLUS® unit, mounting brackets, and/or bolt kits that are found to be defective as a result of the manufacturer's material and/or workmanship.

All warranty considerations must receive a Returned Materials Authorization (RMA#) number assigned from the manufacturer first. Customer may then ship the SAFE T PLUS® unit or mounting brackets to the Austell, Georgia factory location freight prepaid (i.e. at customer's expense). Warranty Replacement units or mounting brackets, bolt kits will be returned to customer at SAFE T PLUS® expense (freight prepaid for return) by regular Ground Shipping Service.

Warranty Disclaimer

This warranty will not apply where a SAFE T PLUS® unit, mounting brackets, and mounting bolts and nuts have been altered from SAFE T PLUS® original construction in any way so as, in our judgment, to affect its stability, functionality, or longevity which has been subject to misuse, negligence, or accident. This warranty does not cover any other component related to a vehicle's steering assembly, front end suspension, or chassis. Further, this warranty does not include any manufacturer responsibility for any incidental or consequential damages resulting in the use of SAFE T PLUS® products. If warranty applies, manufacturer will repair or replace, at their discretion, the SAFE T PLUS® products or any part or component that is deemed defective.

SAFE T PLUS WARRANTY INFORMATION (cont'd)

Manufacturer reserves the right to change or modify any products without assuming obligation to modify any previously manufactured products. This warranty does not apply unless proper installation of genuine factory-provided SAFE T PLUS® products and parts is followed according to factory instructions, or if failure is due to accident, improper use, abusive use, unauthorized repairs are attempted, or purchased from any distributors, dealers, service centers, or retail outlets. If SAFE T PLUS® products are installed but not properly centered and adjusted by consumer, dealer, service center, retail outlet, or other related mechanics, any and all expenses, costs, associated with centering or adjusting SAFE T PLUS® correctly will be at the expense of the customer (purchaser), not the manufacturer. Manufacturer assumes no liability for labor, service costs, freight, or any other incidental or consequential charges or damages incurred by owner or associated dealers, service centers, retail outlets, or related mechanics.

SAFE T PLUS® products considered for warranty must be returned directly to SAFE T PLUS® in Austell, Georgia, in the original box or adequately secured cardboard boxing, freight prepaid. A copy of customer's name, return shipping address, contact information (phone, email) and the Return Material Authorization (RMA#) must be included with the product. In the event of a vehicle accident with SAFE T PLUS® installed, please remove the SAFE T PLUS® Unit and all associated mounting brackets, bolt kits. Contact SAFE T PLUS® factory for a Return Material Authorization (RMA#) number to return all SAFE T PLUS® product for inspection and replacement.

We want to ensure your SAFE T PLUS® products were not damaged and are properly functioning after any type of accident.

The warranty is expressly in lieu of all other warranties expressed or implied and all other obligations or liabilities on our part of any kind or character, including liabilities for alleged representation or negligence.

Warranty Return Information

If your Warranty is approved by SAFE T PLUS® manufacturer, a Return Material Authorization number (RMA#) will be sent to you to return your product. Return shipping costs are at your expense and non-refundable.

Ship your return product (must include the RMA# you are provided) to:

Safe T Plus
Attention: RMA
1230 Six Flags Road
Building C
Austell, GA 30168

We recommend keeping a copy of your tracking number for your records.

ROAD TEST & CENTERING (cont'd)

5. For the person outside of the vehicle, gain access to SAFE T PLUS® unit. Using a socket wrench with a 9/16-inch socket, and loosen Flanged Lock Nuts on Tie-Rod Bracket U-Bolt and allow the SAFE T PLUS® unit to freely move to its centered position. Once the SAFE T PLUS® unit rests at its centered position, using a torque wrench with a 9/16-inch socket, torque Tie-Rod Bracket Flanged Lock Nuts to 25-35 foot pounds (*Figure 3*).
6. Repeat road test until vehicle is able to maintain a straight trajectory. If centering the SAFE T PLUS® unit requires more than 2 or 3 attempts, please contact our technical support team at (770) 322-8727 for further assistance.

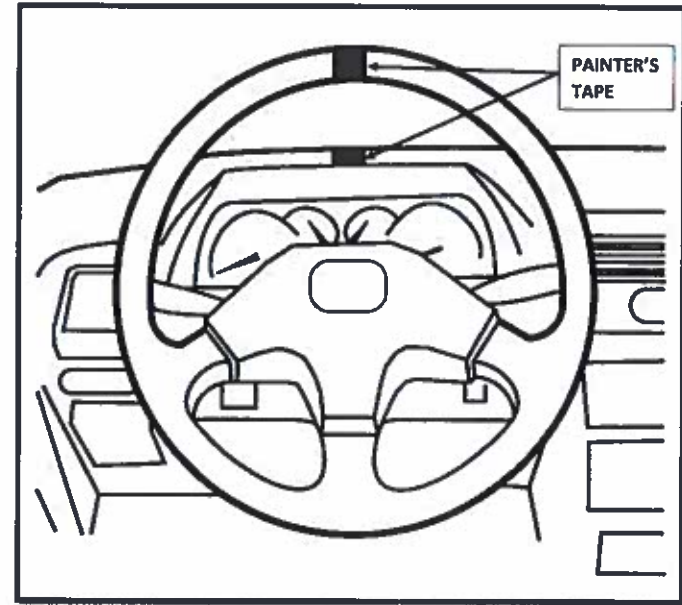

Figure 6. Tape Application to Steering Wheel and Dashboard

ROAD TEST & CENTERING

NOTE

- Two people are recommended for the following step. *If only one person will perform road test, be sure to bring painter's tape to assist with marking steering wheel for proper alignment.*
 - *Bring a socket wrench, 9/16-inch socket, and torque wrench for road test.*
1. Perform road test by driving vehicle on flat, straight surface away from traffic. Drive vehicle without forcing the vehicle to travel straight and note (if any) the direction the vehicle is pulling (left or right). If vehicle maintains a straight trajectory, then this is your final step.
 2. If vehicle is pulling in a certain direction, continue driving the vehicle, but use the steering wheel to hold the vehicle in a straight line.
 3. Stop the vehicle on a flat surface, away from traffic, and hold the steering wheel so that the wheels remain in the straight ahead position.
 4. Place the vehicle in park and engage the emergency brake.



NOTE

- One person must hold the steering wheel so that the wheels remain in the straight ahead position, while the second person steps outside the vehicle to adjust the SAFE T PLUS® unit. If second person is not available, place a strip of painter's tape on the top center of the steering wheel, and place a strip on the dashboard above the instrument cluster, directly in line with tape on steering wheel before exiting the vehicle (Figure 6).
- When loosening Flanged Lock Nuts on the U-Bolts in the following step, allow the SAFE T PLUS® unit to push the Tie-Rod Bracket assembly along the Tie-Rod under its own spring loaded pressure. Do not hammer or force the Tie-Rod Bracket into position.

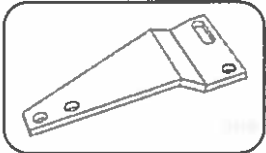
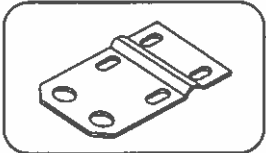
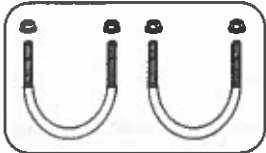
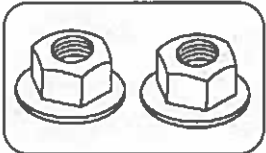
KIT CONTENTS & REQUIRED FASTENERS

NAME AND DESCRIPTION	PART NUMBER	QUANTITY
 Anchor Bracket	55-105-6	1
 Tie-Rod Bracket	55-206	1
 U-Bolt Kit	12-38-1625K (contains two 3/8 x 1-5/8-inch U-Bolts, and four 3/8-16 flanged lock nuts)	1
 1/2-13 Hex Nuts (contained in your Safe T Plus® unit box)	14-400	2

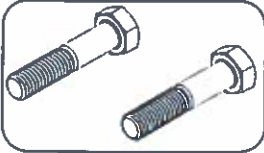
KIT CONTENTS & REQUIRED FASTENERS (cont'd)

NAME AND DESCRIPTION	PART NUMBER	QUANTITY
 13 1/2-13 X 3 Bolts <i>(contained in your Safe T Plus® unit box)</i>	10-4-300	2
 Washers <i>(contained in your Safe T Plus® unit box)</i>	15-850	2

TOOLS REQUIRED

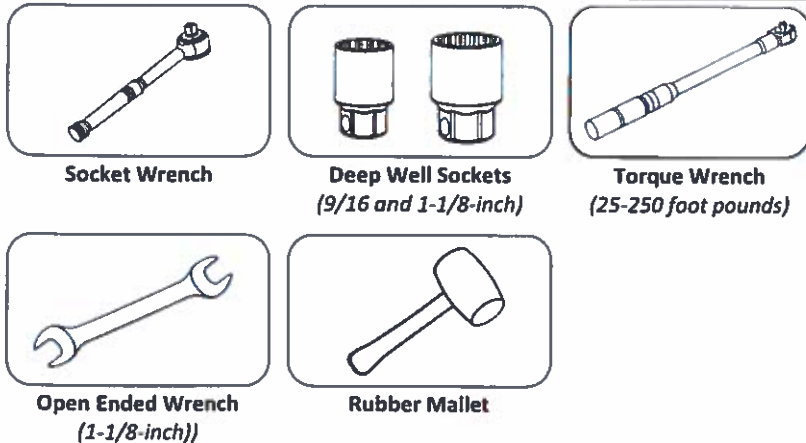

SAFE T PLUS® INSTALLATION (cont'd)

NOTE

Two people are required for the following step. One person should remain inside the vehicle, and the other person outside the vehicle to observe.

WARNING

THE OUTSIDE OBSERVER WILL HAVE TO GAIN ACCESS TO THE FRONT UNDERSIDE OF THE VEHICLE WHILE THE VEHICLE IS OPERATING, AND WHILE THE STEERING WHEEL IS TURNED TO THE EXTREME RIGHT AND EXTREME LEFT. WHILE OBSERVER IS UNDERNEATH VEHICLE, ENSURE THAT:

- PARKING BRAKE REMAINS APPLIED.
- LEVELING JACKS ARE NOT ACTUATED (IF EQUIPPED)
- OBSERVER REMAINS CLEAR OF WHEELS WHEN THEY ARE TURNED LEFT AND RIGHT.

FAILURE TO COMPLY MAY RESULT IN INJURY OR DEATH.

12. Start vehicle. Turn steering wheel to both extreme left and right positions and ensure SAFE T PLUS® unit does not bind or scrape front axle assembly components. If interference is noted, return steering wheel to straight ahead position and shut the vehicle down. Adjust the Tie-Rod Bracket assembly as required. Repeat this step as required until SAFE T PLUS® unit does not interfere with steering components. Should SAFE T PLUS® continue to contact steering assembly components, please contact our technical support team at (770) 322-8727 for further assistance.
13. Installation is complete. The next step is Road Test and Centering, with adjustment if necessary.

SAFE T PLUS® INSTALLATION (cont'd)

WARNING

- OVER TIGHTENING OF TIE-ROD BRACKET FLANGED LOCK NUTS CAN CAUSE IMPROPER FIT AND POTENTIAL FAILURE OF U-BOLTS. IF YOU EXCEED 25-30 FOOT-POUNDS OF TORQUE ON TIE-ROD BRACKET FLANGED LOCK NUTS, TIE-ROD BRACKET WILL BEND CAUSING U-BOLTS TO FLARE OUT. **STOP INSTALLATION IMMEDIATELY AND CALL SAFE T PLUS® TO ORDER A NEW TIE-ROD BRACKET AND U-BOLT KIT.** DRIVING WITH BENT TIE-ROD BRACKET AND U-BOLTS CAN CAUSE A SERIOUS DRIVING ACCIDENT.
- A RUBBER Mallet IS REQUIRED TO GENTLY TAP U-BOLTS INTO PLACE IN THE FOLLOWING STEP. IF U-BOLTS DO NOT REQUIRE GENTLE TAPPING INTO PLACE, CONTACT SAFE T PLUS® CUSTOMER SERVICE TO ENSURE THAT YOU HAVE THE CORRECT PART. PROPER FITTING U-BOLTS ARE A SAFETY REQUIREMENT.

9. Rotate Tie-Rod Bracket assembly until SAFE T PLUS® unit is parallel to Tie-Rod and is able to move freely without potential contact with any other parts on vehicle. Using a torque wrench with a 9/16-inch socket, torque four Flanged Lock Nuts to 25-35 foot pounds (*Figure 3*).
10. Torque Tie-Rod Bolt to Tie-Rod Bracket to 80-90 foot pounds (*Figure 5*).
11. If vehicle is raised, lower vehicle to the ground with full weight on wheels in accordance with vehicle manufacturer's instructions.

SAFETY & OTHER RECOMMENDED ITEMS

NAME AND DESCRIPTION

PURPOSE

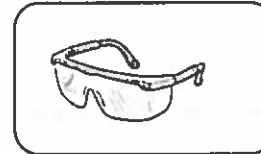

Safety Glasses

Protect eyes from debris while installing SAFE T PLUS®.



Nitrile Gloves

Protect hands from dirt and lubricants during SAFE T PLUS® installation.

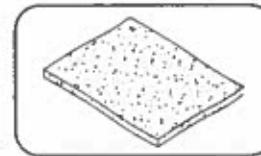

Scotch Brite Pad

Remove dirt and debris from tie rod.



Vehicle Operator's Manual

Reference source.

SAFETY & OTHER RECOMMENDED ITEMS (cont'd)

NAME AND DESCRIPTION

PURPOSE

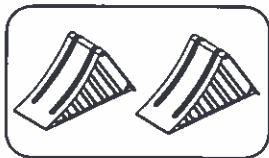

Wheel Chocks

Prevent vehicle from moving when parked.

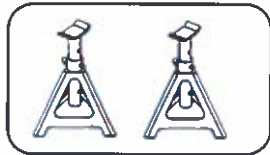

Safety Jack Stands

Support raised vehicle.

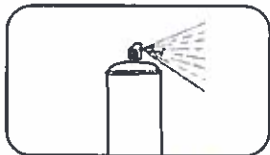

Penetrating Oil Lubricant
(PB Blaster or similar)

Helps to loosen existing nuts on vehicle that may be difficult to remove.

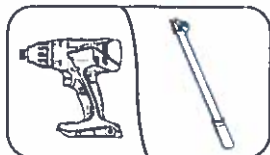

Impact Wrench OR
Breaker Bar

Assist with removal of existing nuts on axle assembly U-bolt if required.

SAFE T PLUS® INSTALLATION (cont'd)

- With Anchor Bolt threads facing up, loosely install large end of SAFE T PLUS® unit to the bottom of Anchor Bracket with Anchor Bolt, Anchor Washer, and Anchor Nut (Figure 4).

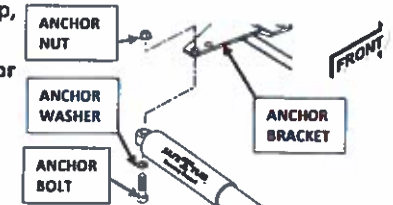

FIGURE 4. SAFE T PLUS INSTALL TO ANCHOR BRACKET

- With Tie-Rod Bolt threads facing up, loosely install small end of SAFE T PLUS® unit to the top of Tie-Rod Bracket with Tie-Rod Bolt, Tie-Rod Washer, and Tie-Rod Nut (Figure 5).

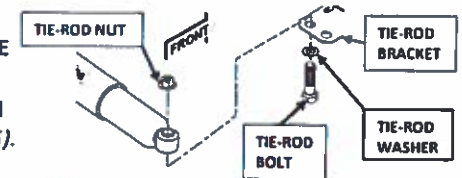

FIGURE 5. SAFE T PLUS INSTALL TO TIE-ROD BRACKET

- Grip head of Anchor Nut with 1-1/8-inch open ended wrench. Using a torque wrench with a 1-1/8-inch socket, torque Anchor Bolt to Anchor Bracket to 120-130 foot pounds (Figure 4).

SAFE T PLUS® INSTALLATION (cont'd)

- Using a socket wrench with a 1-1/8-inch socket, remove two existing nuts (and washers if installed) from axle spring rear U-bolt on driver's side of front axle assembly. If nuts are difficult to remove, apply penetrating oil lubricant and re-attempt removal using a breaker bar or impact wrench for assistance (Figure 2).

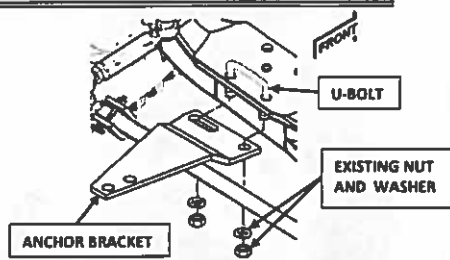

FIGURE 2. ANCHOR BRACKET INSTALL TO AXLE SUSPENSION U-BOLT

NOTE

When installing Anchor Bracket in the following step, ensure Anchor Bracket is mounted angled up from the mounting position and goes above the vehicle tie-rod. The slanted 45 degree angle side of Anchor Bracket should be facing the driver's wheel for proper mounting of SAFE T PLUS® unit.

- Using a torque wrench with a 1-1/8-inch socket, install and secure Anchor Bracket to existing axle spring rear U-bolt with two existing nuts (and washers if previously installed) that were removed in step 2, and torque nuts to a recommended 250 foot-pounds. Be sure to double check your vehicle manufacturer torque specifications of nuts (Figure 2).
- Remove debris from Tie-Rod with Scotch-Brite pad.
- On passenger's side of Tie-Rod, place Tie-Rod Bracket on bottom of the Tie-Rod. With U-Bolt threads facing down, loosely install Tie-Rod Bracket onto Tie-Rod with two U-Bolts and four Flanged Lock Nuts (Figure 3).

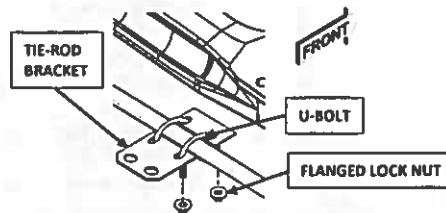
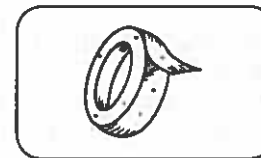

FIGURE 3. TIE-ROD BRACKET INSTALL TO TIE-ROD

SAFETY & OTHER RECOMMENDED ITEMS (cont'd)

NAME AND DESCRIPTION

PURPOSE



Painter's Tape

Apply to steering wheel and dashboard for center steering alignment purposes.

SAFE T PLUS® INSTALLATION

WARNING

FOR VEHICLES WITH ENGINES OR GENERATORS MOUNTED IN THE FRONT, USE CAUTION WHEN WORKING AROUND ENGINE AND EXHAUST COMPONENTS. COMPONENTS CAN REMAIN HOT FOR UP TO AN HOUR AFTER ENGINE OR GENERATOR SHUTDOWN. FAILURE TO COMPLY MAY RESULT IN INJURY.

NOTE

- An installation video is available for your reference at: https://www.youtube.com/watch?v=vsabH_SCVJM&feature=youtu.be Since the installation video may show a different chassis and method of installation, the video is strictly for reference only, and does not supersede the instructions contained in this manual.
- When parking vehicle, ensure that wheels are in a straight ahead position. This can be accomplished by ensuring that your vehicle is traveling straight ahead and stopping the vehicle with the steering wheel in that position.
- Refer to *Figure 1* to familiarize yourself with hardware orientation and installation.

1. Gain access to the underside of front axle assembly.

NOTE

Some vehicles are equipped with a factory-installed dampner. The dampner looks similar to the SAFE T PLUS® unit, with one end attached to the Tie-Rod, and the other end is usually attached to the frame of the vehicle. If dampner is installed, remove dampner, brackets, and mounting hardware in its entirety before continuing with procedure.

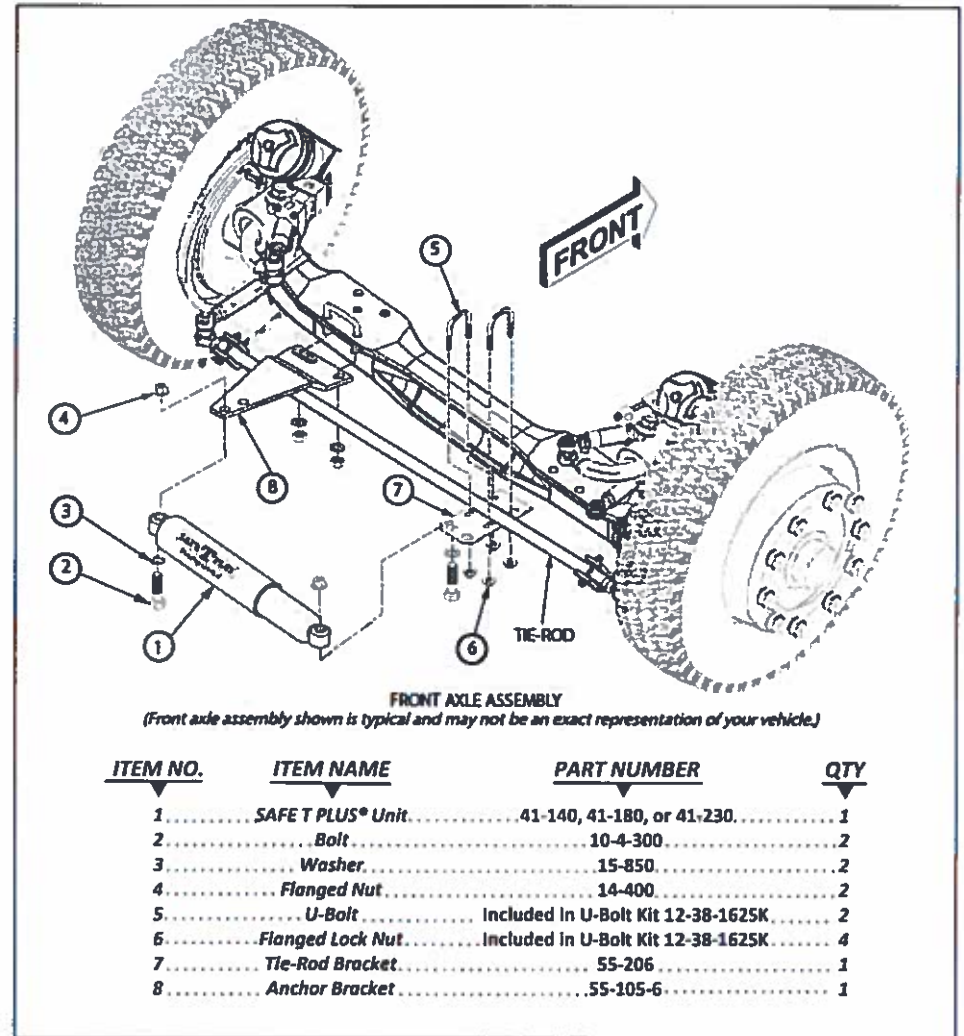

Figure 1. SAFE T PLUS® Unit and Attaching Hardware Installation Diagram